

REV.	DESCRIPTION	DRAWN	CHECKED	APPROVED
A	NEW RELEASE	LJC 11/18/11'		LJC 11/18/11'
B	DRAWING UPDATE	JLZ 02/24/17'		

NOTES:

1.Materials:

- 1.1. Insulator: High Temperature 260°C,UL94-V0
(For White Only UL94-HB Rated),RoHS,REACH compliance.
- 1.2. Pin: Copper Alloy, Plating Tin or Gold.
- 1.3. Clip: Beryllium Copper, C17200,Full Gold plating.

2.Specifications:

- 2.1. Temperature Range: -55~+125°C.
- 2.2. Contact Resistance: 10mΩ maximum.
- 2.3. Insulation Resistance: 1000MΩ minimum.
- 2.4. Dielectric Withstanding Voltage: 500V AC 1 minute.
- 2.5. Voltage Rating: 24V AC/DC.
- 2.6. Current Rating: 3A max per pin.
- 2.7. Application insert pin: Ø0.381~Ø0.635mm.
- 2.8. Resistance to soldering heat: 260°C,3-5seconds.
- 2.9. Durability: 1000 cycles min.

3. Product Number Code:

DS1137 - X X X X X X

- Packing Type
R: Tape On Reel.
- Clip plating(Female Only)
8: Full gold flash.
C: Full 3u" gold.
- Pin plating
6: Full tin.
8: Full gold flash.
- Housing Color
W: White
B: Black
V: Ivory
- Connector Type
F: Female
M: Male
- No. of positions
2: 2p ~ 10: 10p

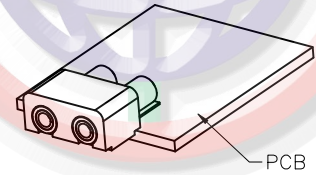
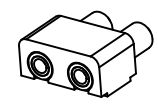
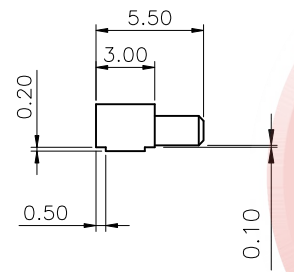
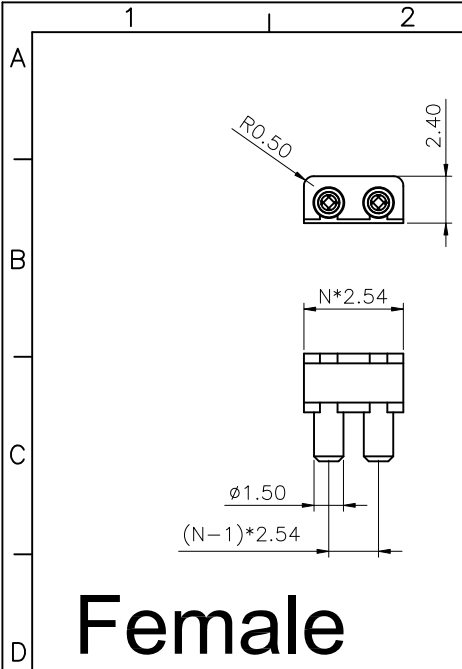

Figure of PCB Mounting

Female

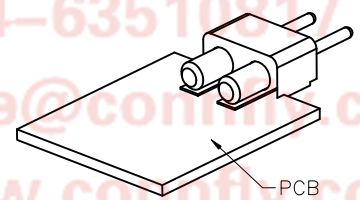
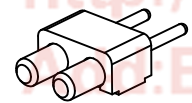
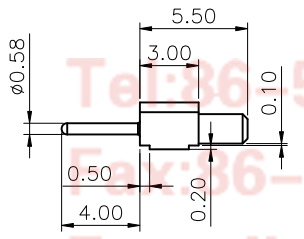
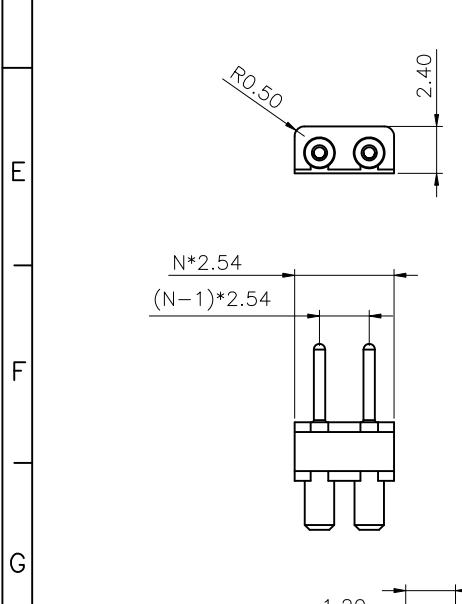
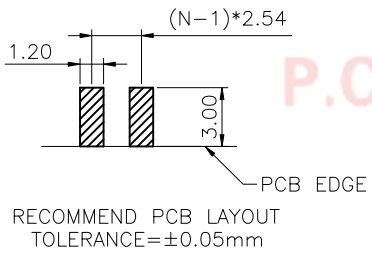

Figure of PCB Mounting

Male



GENERAL TOLERANCE		ANGLE TOLERANCE	
X.	±0.60	X.	±5°
.X	±0.38	.X	±3°
.XX	±0.25	.XX	±2°

DRAWING TYPE	CUSTOMER		
SCALE	1:1	SHEET	1 OF 1
DRAWING NO.	C-DS1137-XXXXXX-B		

PROJECTION	TITLE
	2.54mm LED Series Plug & Socket SMT Type Connector
UNITS	mm
SHEET SIZE	A4
SERIES	DS1137 SERIES

晨翔电子有限公司
CONNFly CONNFly ELECTRONIC CO. LTD

Tel: 36-574-63508787
Fax: 36-574-63510817
E-mail: sale@connfly.com
http://www.connfly.com
East Industry Zone Kuang Yan
Town Cixi Ningbo China
P.C: 315335